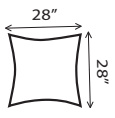
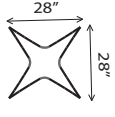
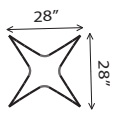
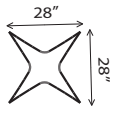
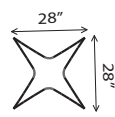

A	Skin	Size
		28" X 28"
	1x1 Flat Front	W H <small>1x1 Flat Front Shown as it will appear on the Xpressions unit</small>

B	Skin	Size
		28" X 28"
	1x1 Flat Front	W H <small>1x1 Flat Front Shown as it will appear on the Xpressions unit</small>

C	Skin	Size
		28" X 28"
	1x1 Flat Front	W H <small>1x1 Flat Front Shown as it will appear on the Xpressions unit</small>

D	Skin	Size
		28" X 28"
	1x1 Flat Front	W H <small>1x1 Flat Front Shown as it will appear on the Xpressions unit</small>

E	Skin	Size
		28" X 28"
	1x1 Flat Front	W H <small>1x1 Flat Front Shown as it will appear on the Xpressions unit</small>

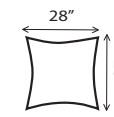
F	Skin	Size
		28" X 28"
	1x1 Flat Back	W H <small>1x1 Flat Back Shown as it will appear on the Xpressions unit</small>

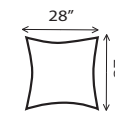
G	Skin	Size
		28" X 28"
	1x1 Flat Back	W H <small>1x1 Flat Back Shown as it will appear on the Xpressions unit</small>

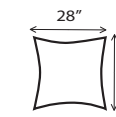
H	Skin	Size
		28" X 28"
	1x1 Flat Back	W H <small>1x1 Flat Back Shown as it will appear on the Xpressions unit</small>

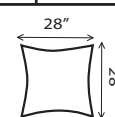
I	Skin	Size
		28" X 28"
	1x1 Flat Back	W H <small>1x1 Flat Back Shown as it will appear on the Xpressions unit</small>

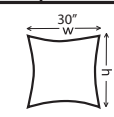
J	Skin	Size
		30" X 28"
	1x1 Horizontal Thread	W H <small>1x1 Horizontal Thread Shown as it will appear on the Xpressions unit</small>

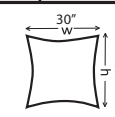
K	Skin	Size
		30" X 28"
	1x1 Horizontal Thread	W H <small>1x1 Horizontal Thread Shown as it will appear on the Xpressions unit</small>

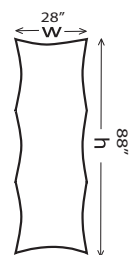
L	Skin	Size
		28" X 88"
	1x3 Double Thread	W H <small>1x3 Vertical Double Thread Shown as it will appear on the Xpressions unit</small>

It is recommended that all text and borders be 2" from the finish size

