



www.american-image.com

EASY ST display details & setup instructions

nimlok®
authorized distributor

easy st K50

K50

Easy ST is a collection of lightweight, portable fabric panel 10' and 20' exhibit booths. Easy ST systems combine various design options and make assembly and packing quick and easy.

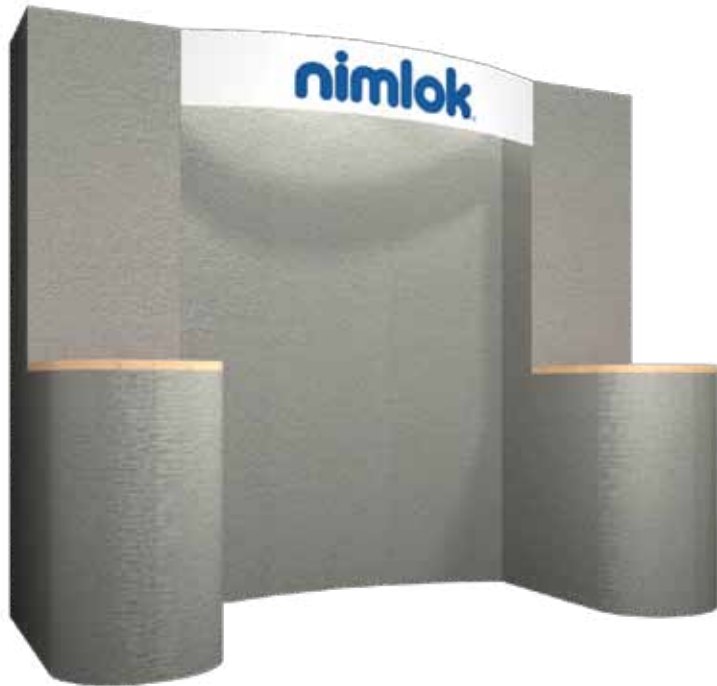

features and benefits:

- Velcro and push-pin-friendly fabric panels in your choice of 18 colors
- Counter tops available in four finishes
- Each panel is numbered for easy assembly
- Comes with 6 5' gently curved fabric panels, 8 fabric panels, 4 half-size fabric panels, 1 graphic header, 3-60 watt rear lights for graphic header, 4 MCW42 cases, 1 MCA case, and 2 KC04 counters
- One year limited warranty against all manufacturers defects

dimensions:

Hardware

Assembled unit: 110"w x 92"h x 65"d
2794mm(w) x 2337mm(h) x 1651mm(d)

Approximate weight: 405 lbs/ 184 kg

Backwall counter: KC04
22"w x 40"h x 34"d
559mm(w) x 1016mm(h) x 864mm(d)

Approximate weight: 65 lbs/ 29 kg

Shipping

Shipping dimensions:
with 4 MCW42 cases and 1 MCA case
each MCW42 case - 50"(l) x 29"(w) x 12"(h)
1270mm(l) x 737mm(w) x 305mm(h)

Approximate shipping weight: (entire kit)
501 lbs/ 227 kg

Graphic

Graphic header: 66.4"w x 11.81"h
1687mm(w) x 300mm(h)

Fabric color options

Regal - smooth textured fabric



Premier - ribbed textured fabric

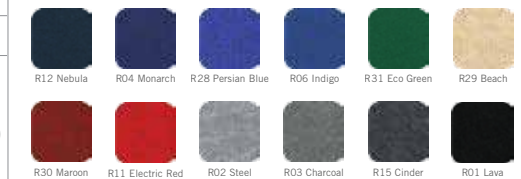

additional information:

Graphic header materials:

UV printed on rollable 22mil PVC

Lights included:

3 60 watt L-LH double bulb fixture

Thermoform finish options

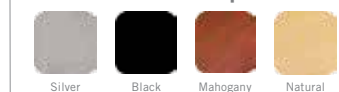

nimlok

easy st

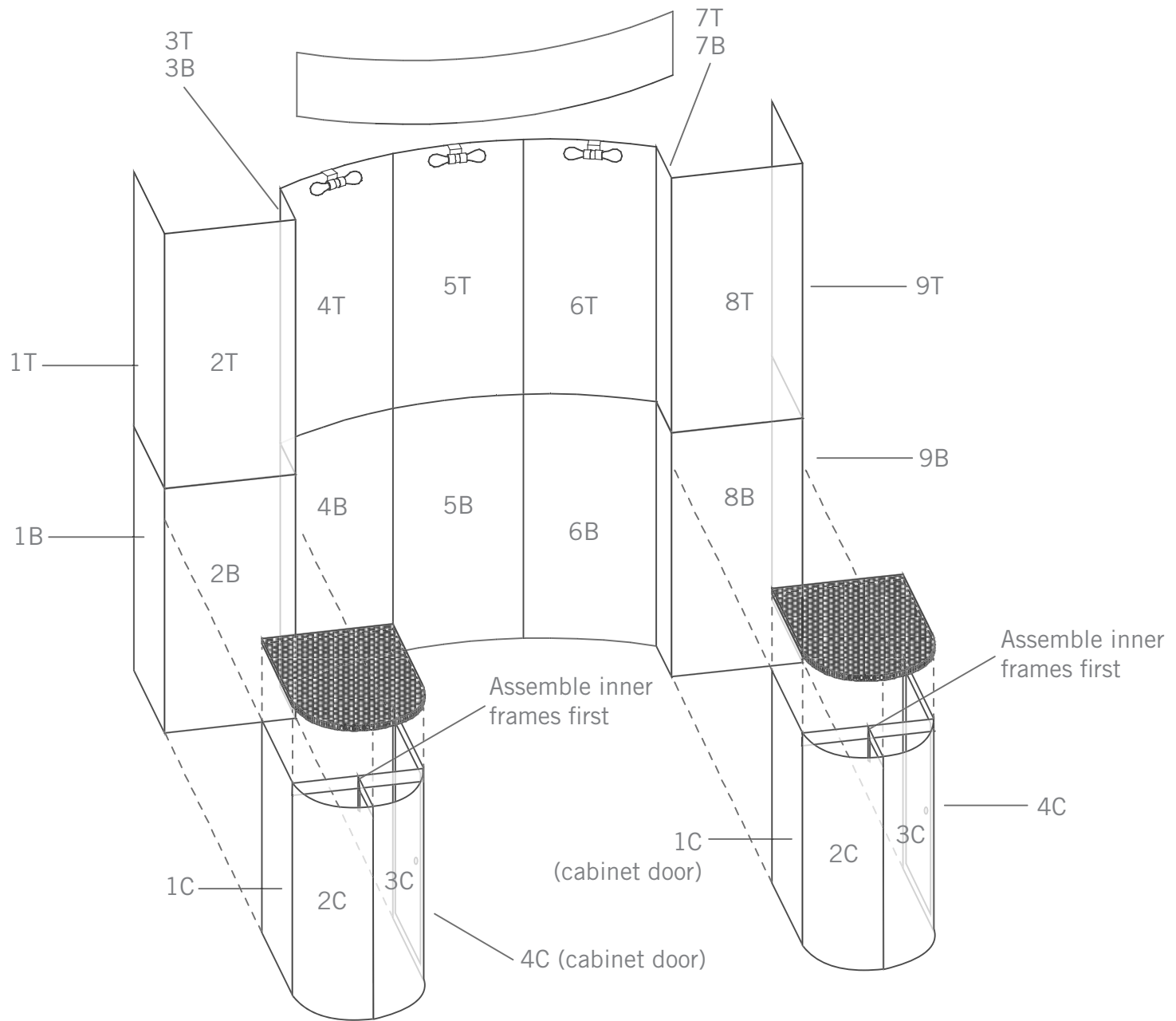

Set-up



Unpack all panels from the cases.
Do not discard the packing material. **1**



All panels are numbered left to right
on the back. Assembly starts from
bottom left panel marked 1B
(1 Bottom) and continues with
panel marked 2B (2 Bottom). **2**

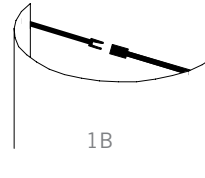

To form a curved panel gently curl
the panel and connect the braces. **3**

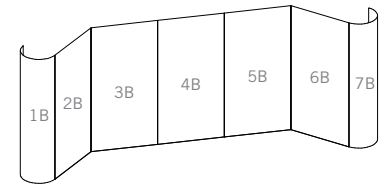

Use page 2 as an angle guide as you
continue building the bottom layer. **4**

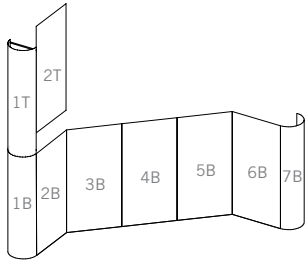

Add the first panel marked 1T (1 Top)
into position. Add the second panel,
2T (2 Top) by sliding the aluminum
link into the routed portion of panel
1T. Slide panel into position. **5**

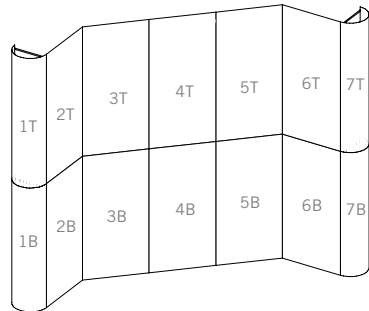

Add the remaining top panels until
assembly is complete. **6**

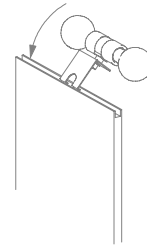

Position light fixtures where indicated
on the panel by placing the lights into
the channel and lower down. **7**

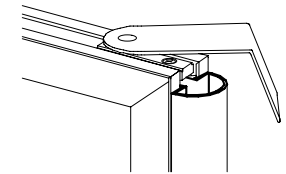

To assemble the header, attach the
separate pieces together with the sliding
connectors top and bottom and tighten
the thumbscrews. The hinged connectors
on the sides of the header hook over the
panels as shown on page 2. **8**

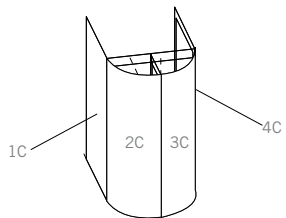

To assemble the counter start with
the left panel working towards the
right until all counter panels have
been connected. **9**

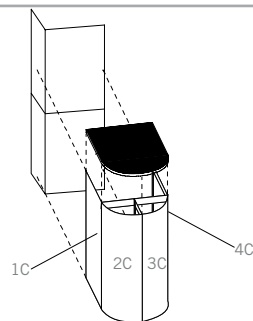

Slide the base of the counter against
the backwall and place counter top
on top of the base of the counter. **10**

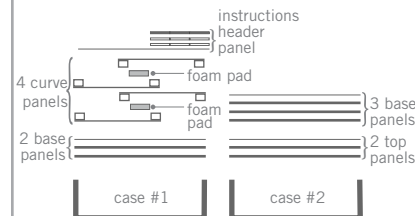

Using the example above, repack
your exhibit. NOTES: Always use
cardboard sheets between panels.
Always pack panels fabric to fabric
or back to back. **11**