



www.american-image.com

EASY ST display details & setup instructions

nimlok®
authorized distributor

easy st K02N

K02N

Easy ST is a collection of lightweight, portable fabric panel 10' and 20' exhibit booths. Easy ST systems combine various design options and make assembly and packing quick and easy.

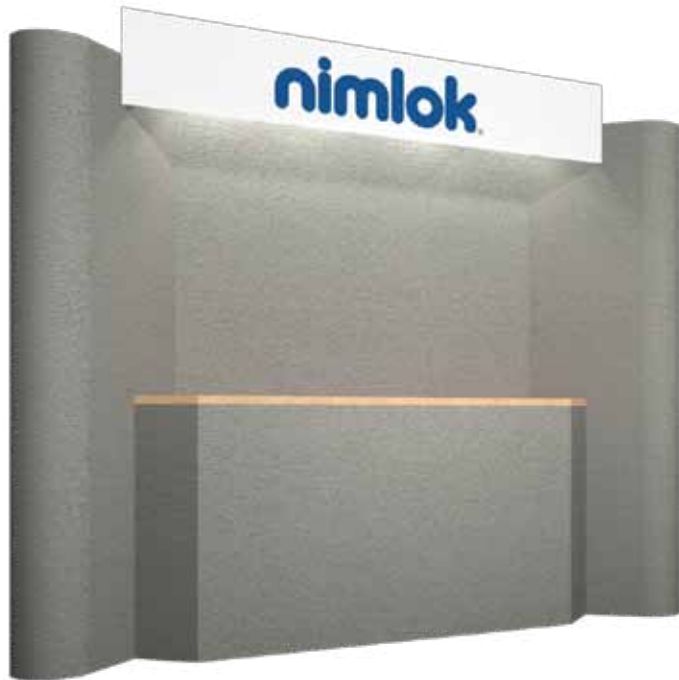

features and benefits:

- Velcro and push-pin-friendly fabric panels in your choice of 18 colors
- Counter tops available in four finishes
- Each panel is numbered for easy assembly
- Comes with 10 fabric panels, 4 curved fabric panels, 1 graphic header, 4-75 watt rear lights for graphic headers, 3 MCW42 cases, 1 header bag, and 1 TU3 counter
- One year limited warranty against all manufacturers defects

dimensions:

Hardware

Assembled unit 120" w x 99" h x 21" d
3048mm(w) x 2515mm(h) x 533mm(d)

Approximate weight: 203 lbs/ 92 kg

Backwall counter: TU3
87" w x 40" h x 21" d
2210mm(w) x 1016mm(h) x 533mm(d)

Approximate weight: 50 lbs/ 23 kg

Shipping

Shipping dimensions: with 3 MCW42 cases each case - 50"(l) x 29"(w) x 12"(h)
1270mm(l) x 737mm(w) x 305mm(h)

Approximate shipping weight: (entire kit)
269 lbs/ 122 kg

Graphic

Graphic header: 86" w x 14.75" h
2184mm(w) x 375mm(h)

Fabric color options

Regal - smooth textured fabric



Premier - ribbed textured fabric

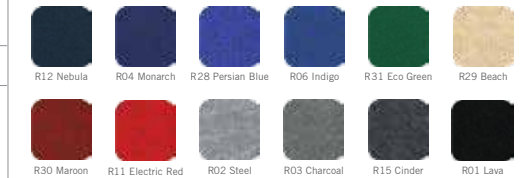

additional information:

Graphic header materials:

UV printed vinyl on 3mm milk plex

Lights included:

4 YLD 75 watt double bulb fixtures

Thermoform finish options

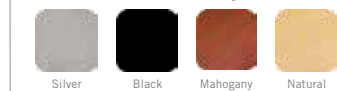

nimlok

easy st

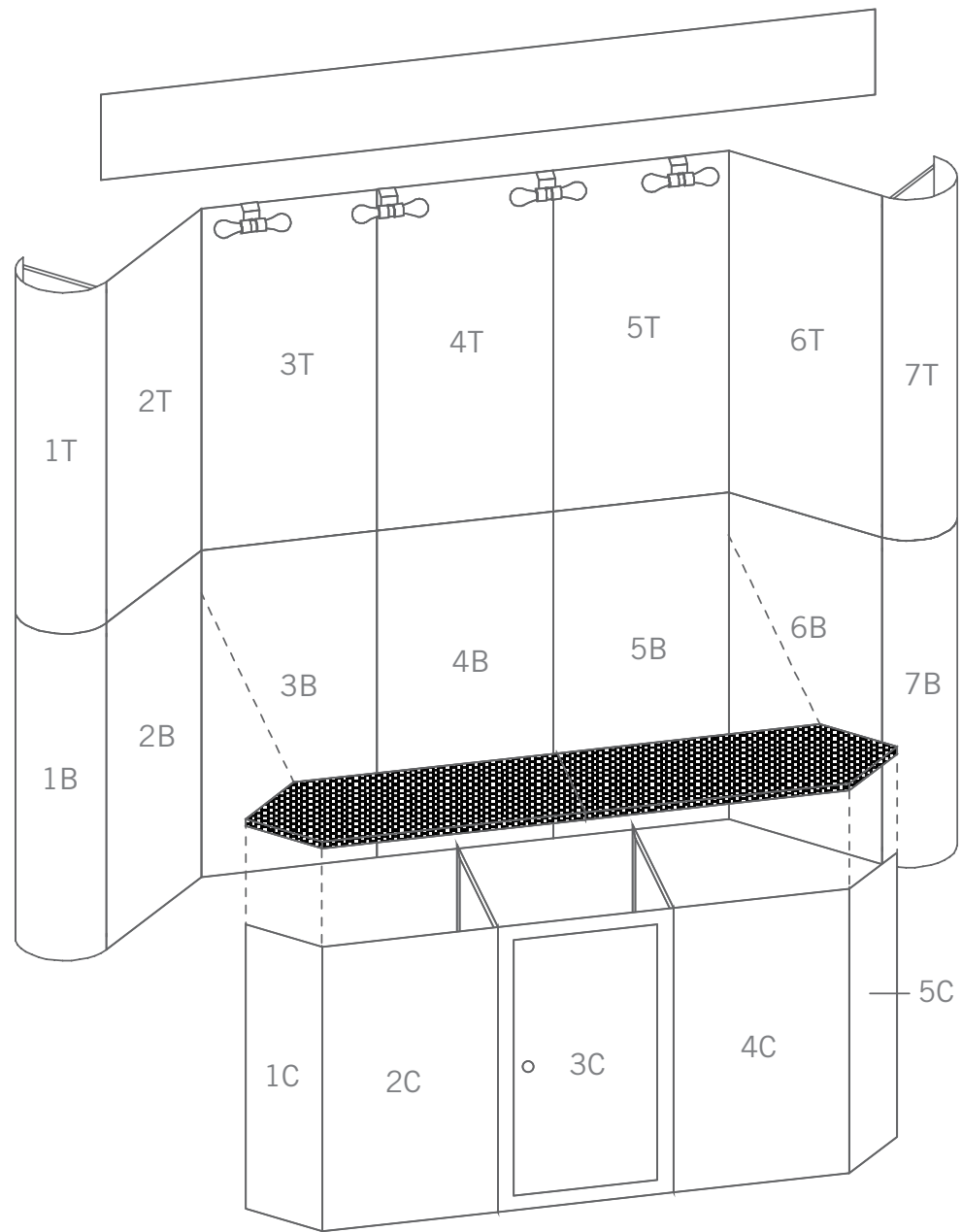

Set-up



Unpack all panels from the cases.
Do not discard the packing material. **1**



All panels are numbered left to right on the back. Assembly starts from bottom left panel marked 1B (1 Bottom) and continues with panel marked 2B (2 Bottom). **2**

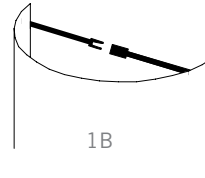

To form a curved panel gently curl the panel and connect the braces. **3**

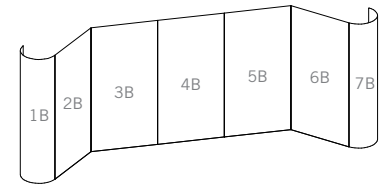

Use page 2 as an angle guide as you continue building the bottom layer. **4**

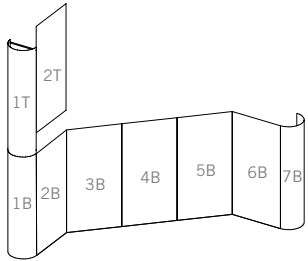

Add the first panel marked 1T (1 Top) into position. Add the second panel, 2T (2 Top) by sliding the aluminum link into the routed portion of panel 1T. Slide panel into position. **5**

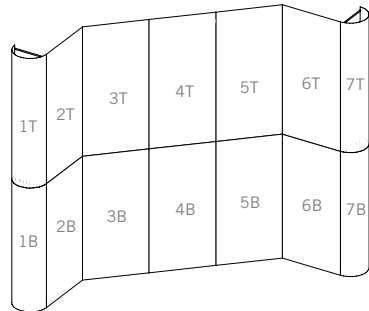

Add the remaining top panels until assembly is complete. **6**

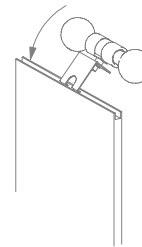

Position light fixtures where indicated on the panel by placing the lights into the channel and lower down. **7**

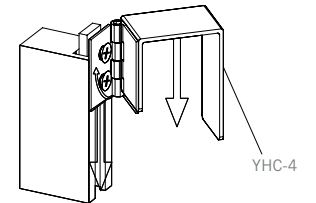

To assemble the header, attach the separate pieces together with the sliding connectors top and bottom and tighten the thumbscrews. The hinged connectors on the sides of the header hook over the panels as shown on page 2. **8**

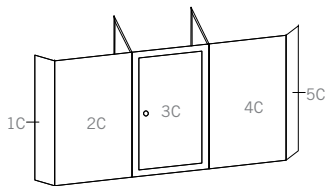

To assemble the counter start with the left panel working towards the right until all counter panels have been connected. **9**

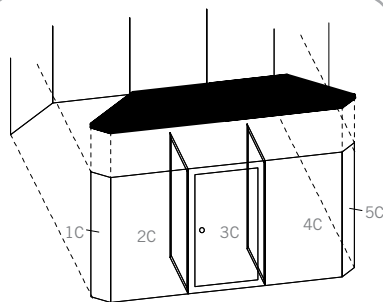

Slide the base of the counter against the backwall and place counter top on top of the base of the counter. **10**

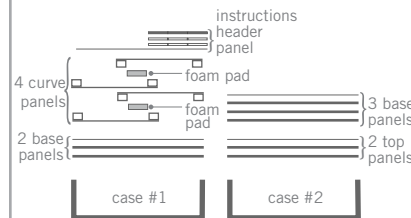

Using the example above, repack your exhibit. NOTES: Always use cardboard sheets between panels. Always pack panels fabric to fabric or back to back. **11**